

Tee

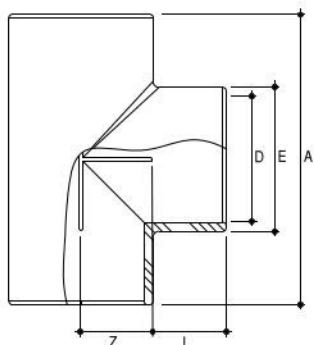

mm / inch	Code 1 / Code 2	A	E	D / ASTM	L	Z	PN	Box
20 / -	133301 / -	58	25	20 / -	16	13	16	150
25 / -	133302 / -	66	31	25 / -	19	14	16	300
32 / -	133303 / -	78	38,5	32 / -	22	17	16	200
40 / -	133304 / -	98	48	40 / -	26	23	16	100
50 / 1-1/2"	133305 / 133305ASTM	120	59	50 / 48.3	34	26	16	115
63 / 2"	133306 / 133306ASTM	145	72	63 / 60.3	38	31	16	75
75 / -	133307 / -	166	85	75 / -	45	40	16	50
90 / 3"	133308 / 133308ASTM	200	101	90 / 88.9	52	48	16	30
110 / -	133309 / -	238	122	110 / -	60	60	16	20
125 / -	133310 / -	268	139	125 / -	69	65	16	11
140 / -	133311 / -	294	156	140 / -	76	71	16	8
160 / -	133312 / -	332	180	160 / -	86	81	16	5
200 / -	133313 / -	415	220	200 / -	106	101.5	10	3
225 / -	133314 / -	468	246	225 / -	119	115	10	2
250 / -	133315 / -	518	276	250 / -	132	126	10	1
280 / -	133316 / -	617	317	280 / -	159	150	10	1
315 / -	133317 / -	651	352	315 / -	164	161.5	10	1

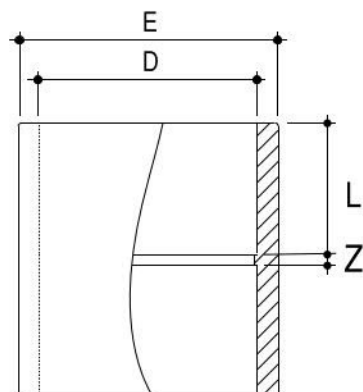

mm / inch	Code 1 / Code 2	E	D / ASTM	L	Z	PN	Box
20 / -	133821 / -	25	20 / -	16	6	16	500
25 / -	133822 / -	31	25 / -	19	4	16	500
32 / -	133823 / -	39	32 / -	22	3	16	300
40 / -	133824 / -	48	40 / -	26	5	16	250
50 / 1-1/2"	133805 / 133805ASTM	60	50 / 48.3	31	3	16	150
63 / 2"	133806 / 133806ASTM	75	63 / 60.33	38	3	16	87
75 / 2-1/2"	133807 / 133807ASTM	89	75 / 73	44	3	16	96
90 / 3"	133808 / 133808ASTM	105	90 / 88.9	51	2	16	60
110 / 4"	133809 / 133809ASTM	128	110 / 114.3	59	5	16	36
125 / -	133804 / -	139	125 / -	69	6	16	24
140 / -	133803 / -	155	140 / -	75	6	16	15
160 / -	133802 / -	186	160 / -	86	8	16	12
200 / -	133810 / -	219	200.5 / -	108	10	10	5
225 / -	133811 / -	247	225.5 / -	199.5	12	10	3
250 / -	133812 / -	279	250 / -	131	7	10	1
280 / -	133813 / -	380	317 / -	148	10	10	1
315 / -	133814 / -	352	315 / -	164	16	10	1

Socket

